

LED High Bay

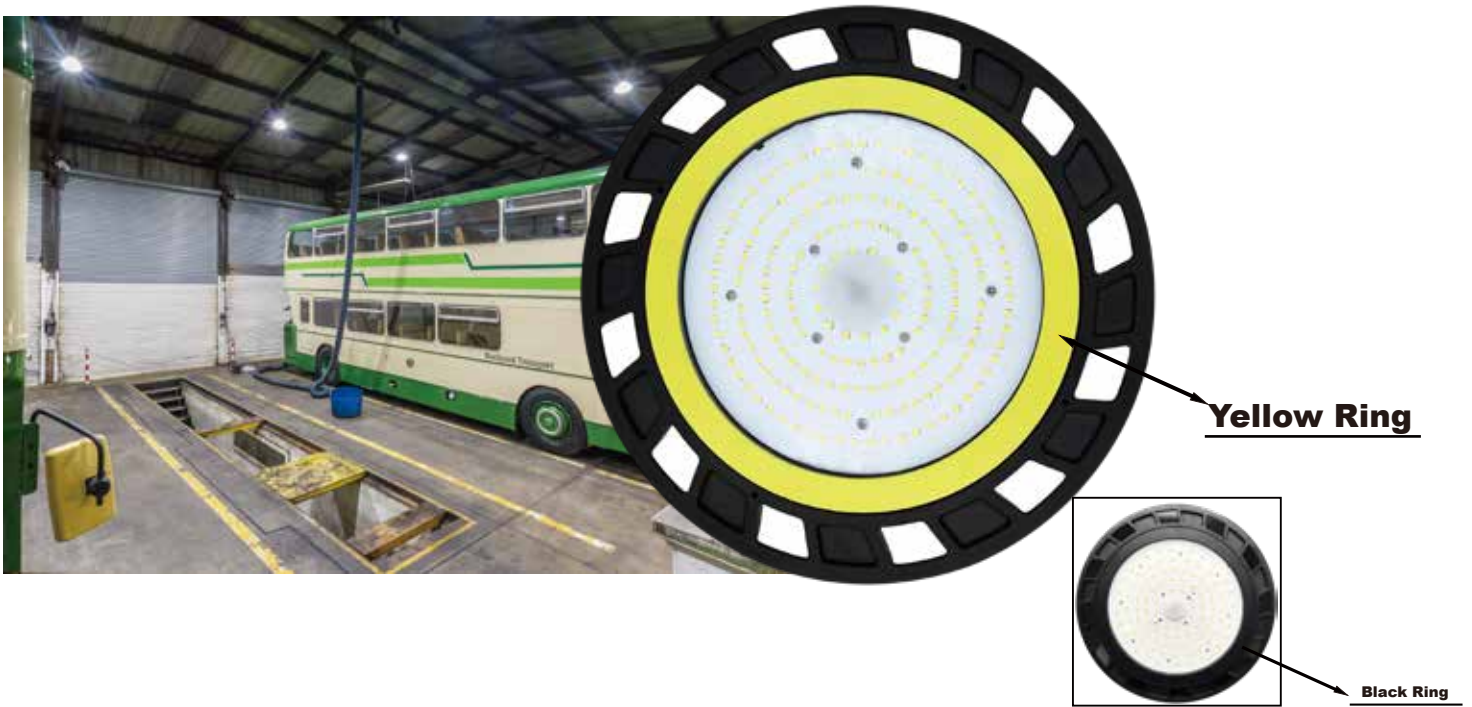

Product Spec:

Product Code	Dimension [L*W*H] [mm]	Power [W]	Input Voltage [V]	Efficiency [lm/W]	Color Temp[K]	CRI	Beam Angle	IP	LED Chip
AL-HB06-100W	260*260*164mm	100W	AC100-277V	150lm/W	3000K-6500K	≥80	60°90°120°	IP65	SMD2835
AL-HB06-150W	305*305*171mm	150W	AC100-277V	150m/W	3000K-6500K	≥80	60°90°120°	IP65	SMD2835
AL-HB06-200W	343*343*178mm	200W	AC100-277V	150m/W	3000K-6500K	≥80	60°90°120°	IP65	SMD2835



Details:



Dimension(mm):

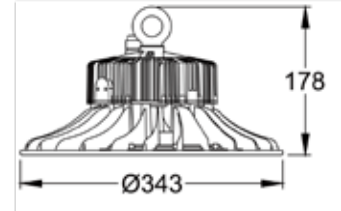
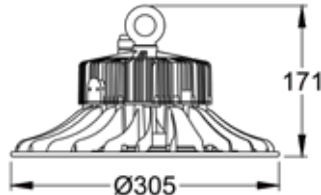
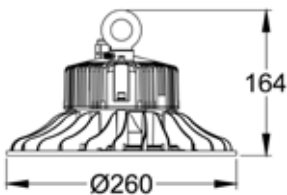

Luminous Intensity Distribution:

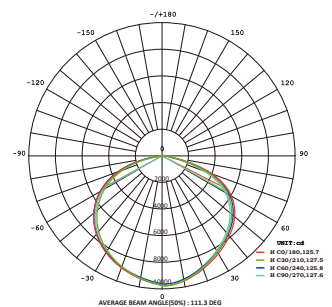
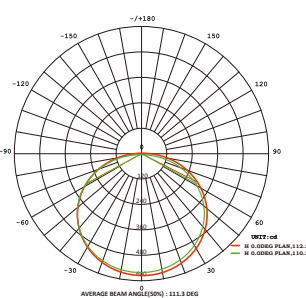
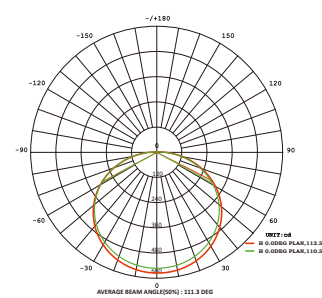

Flux out: 12627 lm

Height	Beam	Diameter
1m	1566.3271lx	293.26cm
2m	391.5307lx	586.53cm
3m	174.0385lx	879.79cm
4m	97.90326lx	1173.06cm
5m	62.66308lx	1466.32cm
6m	43.51145lx	1759.59cm
7m	31.92106lx	2052.85cm
8m	24.68168lx	2346.12cm
9m	19.34643lx	2639.38cm
10m	15.66327lx	2932.64cm

Height: 10m, Beam: 111.43deg, Diameter: 2932.64cm

100W

Flux out: 12627 lm

Height	Beam	Diameter
1m	2025.8241lx	287.26cm
2m	506.4570lx	574.53cm
3m	224.8748lx	861.79cm
4m	125.9426lx	1148.12cm
5m	80.36273lx	1435.38cm
6m	55.96189lx	1722.64cm
7m	41.11393lx	2009.90cm
8m	31.68106lx	2297.16cm
9m	24.8746lx	2584.42cm
10m	20.11682lx	2871.68cm

Height: 10m, Beam: 112.36deg, Diameter: 2871.68cm

150W

Flux out: 12627 lm

Height	Beam	Diameter
1m	2071.9891lx	287.26cm
2m	517.7469lx	574.53cm
3m	232.1099lx	861.79cm
4m	129.4212lx	1148.12cm
5m	85.84382lx	1435.38cm
6m	57.62272lx	1722.64cm
7m	42.36159lx	2009.90cm
8m	30.71480lx	2297.16cm
9m	24.38480lx	2584.42cm
10m	19.90431lx	2871.68cm

Height: 10m, Beam: 125.68deg, Diameter: 2871.68cm

200W

Installation diagram:

◆ **Hook Mounting Installation**

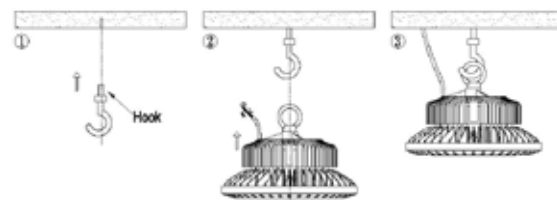

- Drill corresponding size holes in the ceiling . Put the hook into the holes.
- Making the full fixture 's ring hang on the hook. Keeping it stable.
- Notes distinguish the L / N / GND line.

◆ **Hanging chain Installation**

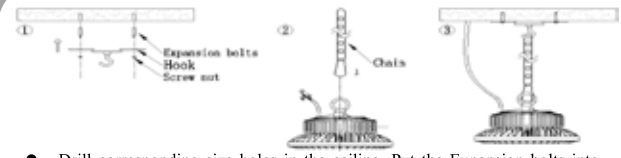

- Drill corresponding size holes in the ceiling. Put the Expansion bolts into holes. Fixed the hook on the ceiling with nut
- As Photo 2 showing , Using the chain's buckle button up the fixture's ring.
- As photo 3 showing , Hanging the chain's another-side ring on the hook with carefully
- Notes distinguish the L / N / GND line.

◆ **Ceiling Installation**

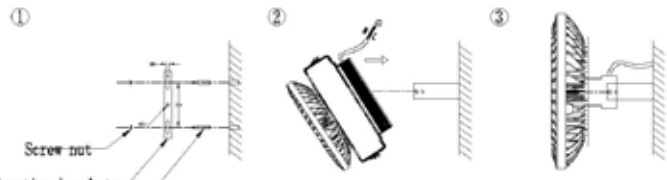

- Drill corresponding size holes in the ceiling, Put the Expansion bolts into holes. Fixed the hook on the ceiling with nut
- Locking up the fixture's bracket and Wall-mounting bracket with screw . Which in a reasonable beam angle.
- Notes distinguish the L / N / GND line

Package Details:

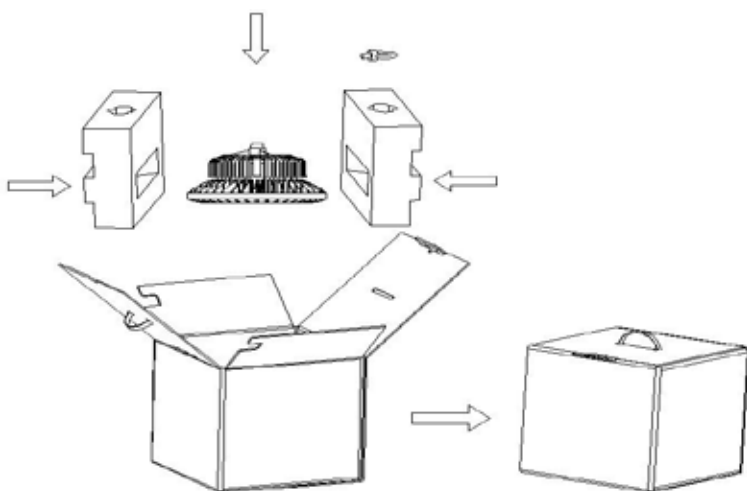

➤ **Packing Size:** 320*320*230 mm
G.W: 3.1KG



Storage Environment :

- Ambient operating temperature range: -20 °C --- + 40 °C
- Environmental Storage temperature range: -25 °C --- + 65 °C
- Environmental Ratings: dry and ventilated moisture-free environment